



إدارة المناهج والكتب المدرسية

Action Pack

4

**Fourth Grade
(New Edition)**

Activity Book

Mandy Loader

The Ministry of Education has decided to adopt this book for Jordanian schools in accordance with the approval of the Board of Education decision No. 4/2013 in its meeting on 17/6/2013 for the 2013/2014 academic year.

All rights reserved to the Ministry of Education

Evaluation and Adaptation Committee

Dr. Hamza Ali Al-Omary

Malak Mohammad Al-Massad

Dr. Hussein Mohammad Yagi

Manal Fahed Abu Rumman

Dr. Fadia Fayez Al-Suyoufie

Nuha Sulaiman Al-Tarawneh

Dr. Saleh Hassan Al-Omary

Oba Talal Abu Hamdeh

Isam Radwan AlKasasbeh

Ahmad Hussein Al-Qisi

Haifa Hafez Takrouri

Production: Dr. Haroun Abd AlJaleel Ali

Proofreader: Dr. Adnan Ahmad AL-Omari

Reviewer: Dr. Manal Fahed Abu Rumman

ISBN: 978-614-406-567-9

Printed 2013

Reprinted 2014-2024

Contents

First semester

| | | |
|--------|-----------------------------------|----|
| UNIT 1 | We always do our homework | 4 |
| UNIT 2 | We sometimes play volleyball | 8 |
| UNIT 3 | I'm reading about Jordan | 12 |
| UNIT 4 | Review | 16 |
| UNIT 5 | The dolphins are jumping | 19 |
| UNIT 6 | We're going to visit a farm | 23 |
| UNIT 7 | We're travelling to Ajloun today! | 27 |
| UNIT 8 | Squirrels are smaller than deer | 31 |
| UNIT 9 | Review | 35 |

Second semester

| | | |
|----------------------|------------------------------------|----|
| UNIT 10 | The Earth isn't the biggest planet | 38 |
| UNIT 11 | Our city wasn't called Amman | 42 |
| UNIT 12 | We visited a museum | 46 |
| UNIT 13 | Review | 50 |
| UNIT 14 | We didn't live in a city | 53 |
| UNIT 15 | What time did you arrive? | 57 |
| UNIT 16 | I found an old coin | 61 |
| UNIT 17 | Plants must have water | 65 |
| UNIT 18 | Review | 69 |
| Alphabet Practice | | 72 |
| Numbers Practice | | 75 |
| Handwriting Practice | | 76 |
| Assessment | | 79 |

We always do our homework

1

Read and match

1. It's the break now.
 2. This is the lab.
 3. This is the hall.
 4. Here is the library.
 5. That's the park.
 6. Do you want to come with us?
- a) We never talk in here.
 - b) Yes, thank you!
 - c) We can show you around the school!
 - d) We have our P.E. lessons here.
 - e) We always have Science here.
 - f) I always go there with my parents.

2

Read, look and complete

hall library park lab

1. We always have Science in the lab.

2. We always read books in the _____.

3. We do P.E. in the _____.

4. At the weekends we ride
our bikes in the _____.

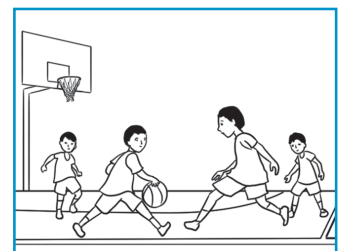
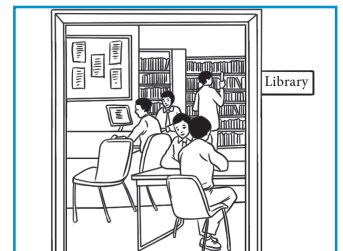
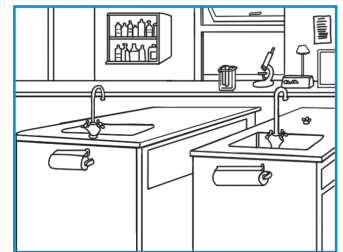

3

Ask and answer

What's the time?

It's a quarter past nine!

1.

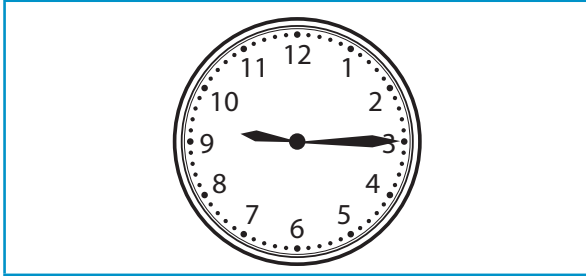

2.

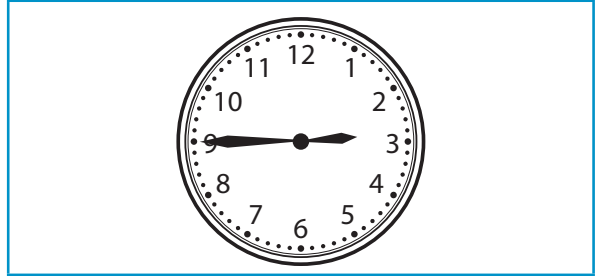

3.

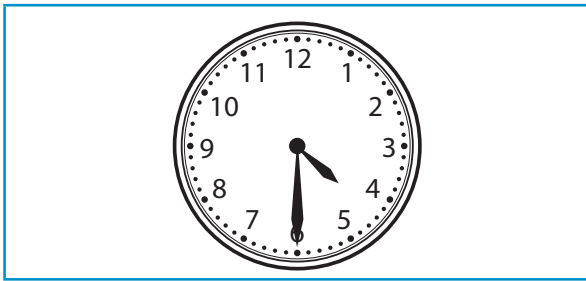

4.

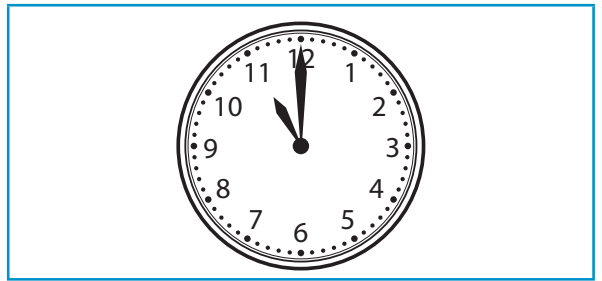

4

Complete

always never

- 1. I always brush my teeth after breakfast.
- 2. I _____ talk in the library.
- 3. I _____ do my homework after school.
- 4. I _____ get up late.
- 5. I _____ forget my schoolbooks.
- 6. I _____ listen to my teacher.

5 Trace and copy

ar ar ar ar ar

car

arm

ea ea ea ea ea

ear

teacher

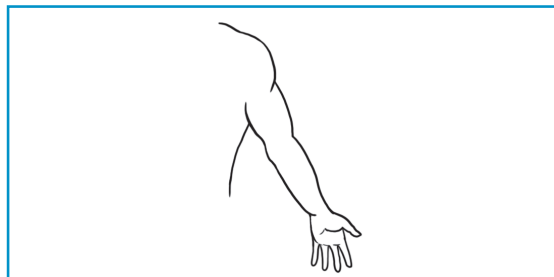
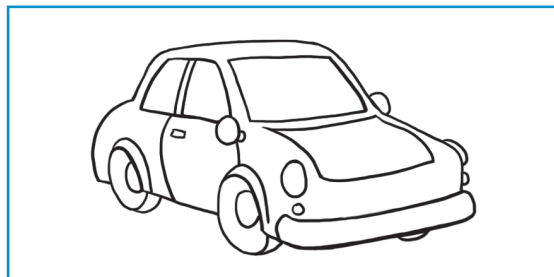

6 Write and say

ea ar

1. Our house is near a park.

2. We go shopping in the market.

3. Kareem and Samira like Amman.

7 Complete and write

What is your favourite subject?



| | |
|----|---------------------------------|
| | What is your favourite subject? |
| Me | |
| A | |
| B | |

Me: My favourite subject is _____ .

A: _____ .

B: _____ .

8 Listen and point



sh ch

9 Order and write

1. favourite / day / My / Friday. / is

My favourite d _____ i _____ F _____

2. is / subject / Arabic. / favourite / My

M _____ f _____ s _____ i _____ A _____

We sometimes play volleyball

1 Read and circle Yes or No

| | What is their favourite sport? | What sport are they good at? |
|---------------|--------------------------------|------------------------------|
| Laila | volleyball | table tennis |
| Samira | table tennis | table tennis volleyball |
| Kareem | running | running |

- Kareem is good at running. Yes/ No
- Samira's favourite sport is volleyball. Yes / No
- Laila is good at table tennis. Yes / No
- Samira is good at table tennis and volleyball. Yes / No
- Kareem's favourite sport is volleyball. Yes / No
- Laila's favourite sport is running. Yes / No

2 Look and write

I like playing table tennis. I'm good at playing volleyball.
I sometimes play handball. Kareem can run very fast!



Kareem can run very fast!

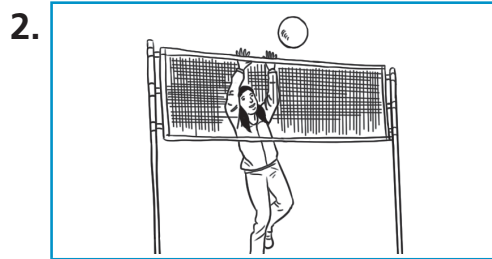

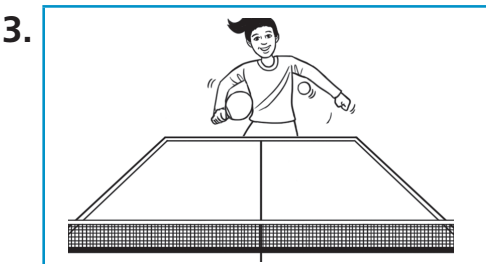

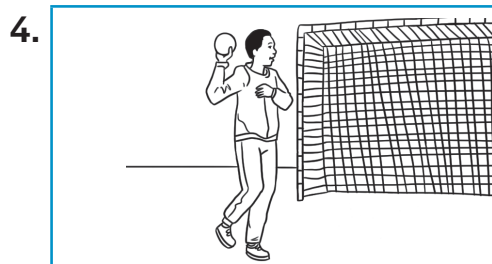

3

Read and match

- 1. What sports do you play?
 - 2. Can you sail?
 - 3. Do you play table tennis?
 - 4. Do you like swimming?
 - 5. What sport are you good at playing?
- a) Yes, I do. I like playing table tennis.
 - b) Yes, I do – but I'm not very good at swimming!
 - c) I'm good at playing volleyball.
 - d) I play handball and I sometimes play volleyball.
 - e) No, I can't! I never go sailing.

4

Read, look and complete

table tennis handball volleyball running swimming sailing

1.

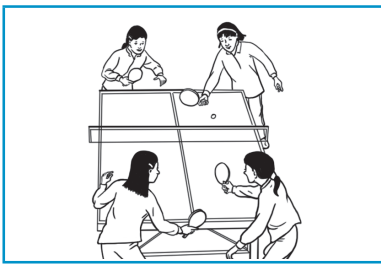

*I'm good at playing
table tennis.*

2.



I sometimes play

3.

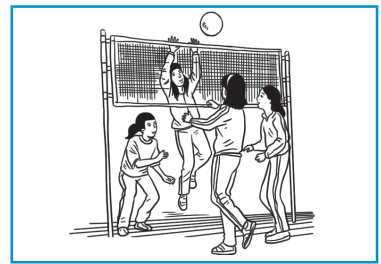

We like playing

4.



I never go

5.

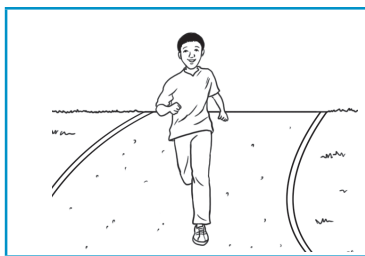

I'm not very good at

6.

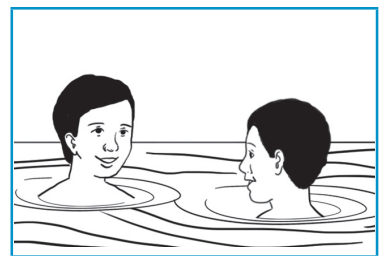

I like

5

Trace and copy

an an an an an

hand

banana

un un un un un

sun

run

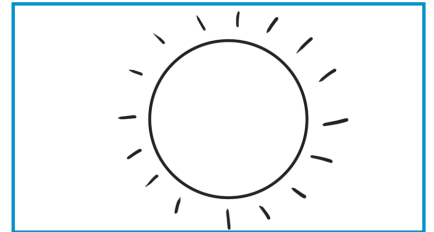
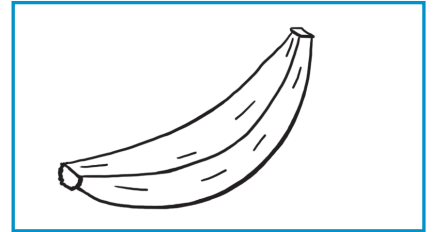
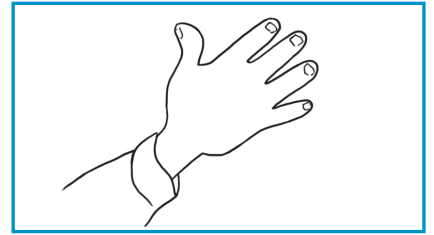

6

Complete the letter

football match stadium team win fun sometimes

Dear Khaled,

How are you? I'm having (1) fun . I'm at King Abdullah

(2) _____ . I'm watching a (3) _____

_____ . My favourite (4) _____ is playing. They

aren't very good at playing football but they (5) _____

(6) _____ ! Write to me soon.

Best wishes,
Kareem

7



Listen and point

thank the

8

Look and write the sport

1.

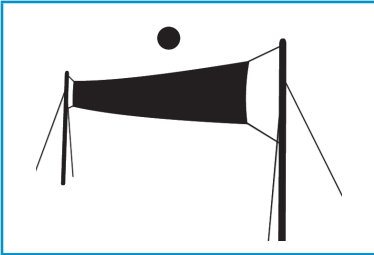

volleyball

2.



3.

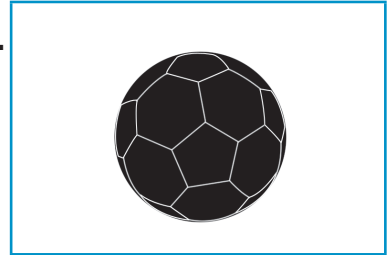

4.



5.



6.



9

Write about you

1. I like playing *table tennis*

2. I'm good at

3. I sometimes play

4. My favourite sport is

5. I'm not very good at

I'm reading about Jordan

1 Read and order

- a) Yes, it is. I'm learning about eagles for our school project.
- b) I'm reading a book about birds.
- c) Let's work on our project after lunch. We can use the computer.
- d) Okay!
- e) What are you doing, Samira?
- f) Is the book good?

2 Read, look and complete

setting reading using
learning sending writing

- 1. I'm reading a book.
- 2. I'm _____ a letter.
- 3. I'm _____ the table.
- 4. We're _____ the computer.
- 5. I'm _____ an email.
- 6. We're _____ about Jordan.

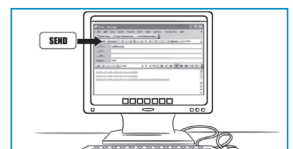
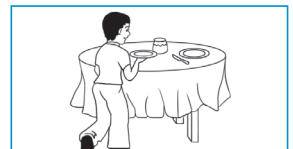
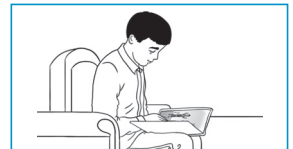

3 Write with capital letters

1. mum is cooking chicken and rice.

Mum is cooking chicken and rice.

2. dad is reading about jordan.

3. issa is helping mum.

4. he's setting the table.

5. alia is writing her diary.

6. she is doing a school project about amman and aqaba.

4 Read and circle Yes or No

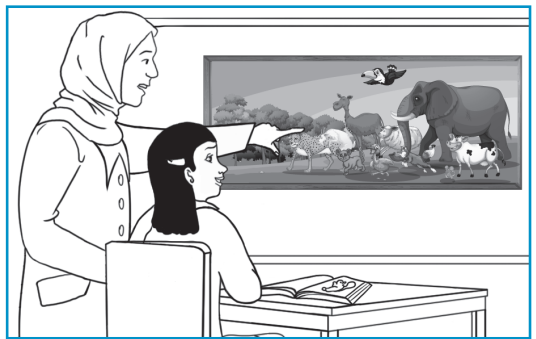

1. Alia is sitting in her classroom at school.

Yes / No

2. She's learning about animals.

Yes / No

3. She's writing in her diary.

Yes / No

4. Issa is reading a book.

Yes / No

5. Issa is using a computer.

Yes / No

6. He's working on a school project about sports.

Yes / No

7. The teacher is sending an email.

Yes / No

8. The teacher is speaking to Alia.

Yes / No

5

Look and write

visiting the waterfalls driving through the mountains
going to Aqaba swimming in warm water

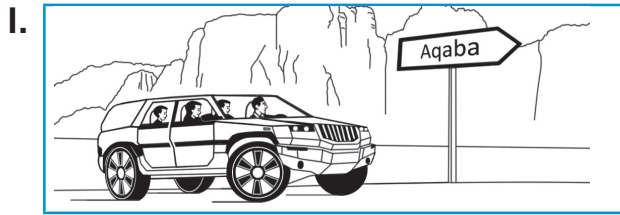

We're going to Aqaba!

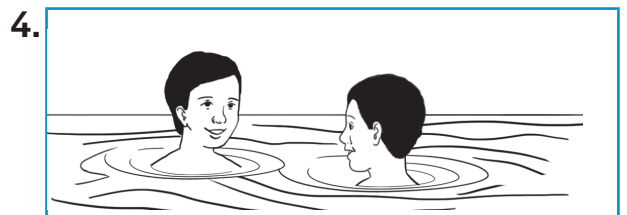
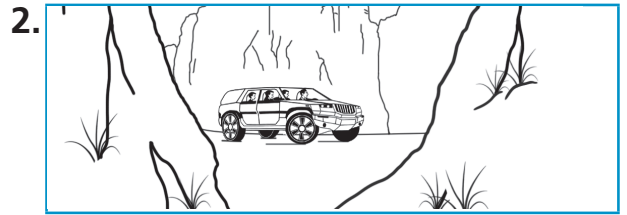

6

Trace and copy

J J J J J

Jordan

C C C C C

Canada

M M M M M

Maths

L L L L L

Laila



2 + 2 = 4



7



Listen and point

bl cl fl

8

Read and match

1. I like using the mouse!

a)



2. I'm sending an email from my computer.

b)

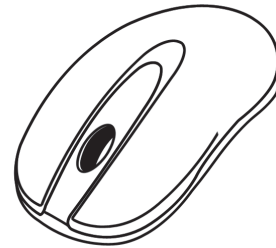

3. Look at the monitor!
It shows you the waterfalls at Hammamat Ma'in.

c)



4. I'm using the printer.
I'm doing my project.

d)



5. I'm writing a diary but
I'm not very fast on the
keyboard!

e)



Review

1 Copy and complete the punctuation

? .

1. This is our diary
2. Do you write a diary
3. We are learning about Aqaba
4. Our school project is about Jordan
5. Do you like sailing
6. Kareem is good at swimming

This is our diary.

2



Listen and complete

table tennis swimming sailing volleyball running handball

| | Name | good at | not very good at |
|---|-------|-------------------|------------------|
| 1 | Ali | <i>volleyball</i> | <i>running</i> |
| 2 | Salma | | |
| 3 | Omar | | |
| 4 | Huda | | |

3

Read and write about you

always sometimes never in the afternoon after school
at six o'clock at half past three

1. What do you do after school?

I sometimes go to the sports centre.

2. When do you do your homework?

3. What sports do you play?

4. When do you play sports?

5. What do you do on Saturdays?

4

Write an email to a new friend

Hi!

How are you? I am very well. Do you like sports? My favourite sport

is _____ . What's your favourite sport? What do you

do at the weekend? I always _____ and I sometimes

What's your favourite subject at school? I'm good at

_____ and my favourite subject is _____ .

Yours,

5 Trace and copy

man

Mum

van

ice

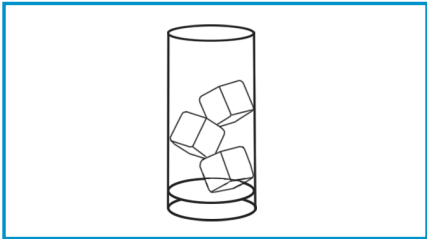
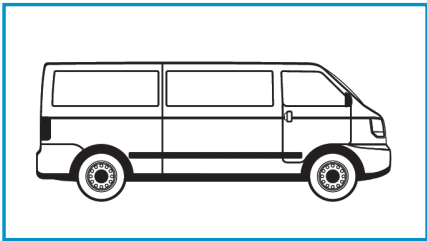
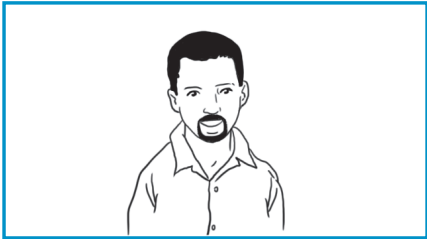

6 Read and say

1. chicken *ch*

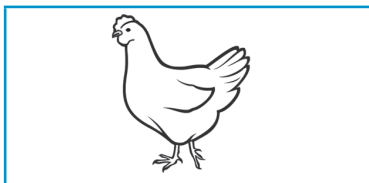

2. shop *sh*



3. theatre *th*

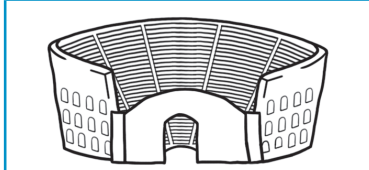

4. weather *th*



5. black *bl*

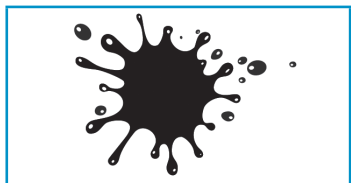

6. clock *cl*



7. flower *fl*



The dolphins are jumping

1

Look, copy and answer

~~No, we aren't.~~ No, it isn't. Yes, we are. Yes, it is.

1. Are you waiting for the glass bottom boat?

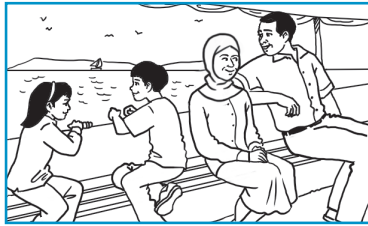

No, we aren't

2. Look! Is it a shark?



3. Is the dolphin playing with the fish?

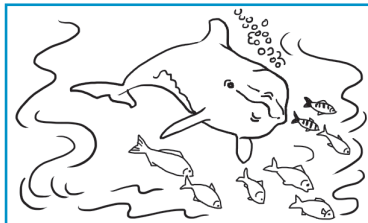

4. Are you looking at the fish in the sea?



2

Order and write

1. are / a / boat. / waiting / We / for

We are waiting for a boat.

2. fast. / boat / The / sailing / isn't

The _____ fast.

3. is / the / dolphins. / making / a / video / Kareem / of

Kareem _____ dolphins.

3

Read and match

- | | |
|--|--|
| 1. Are they waiting for a bus? | a) No, she isn't. She's phoning her grandmother. |
| 2. Is he taking some photos? | b) No, it isn't. It's eating the fish! |
| 3. Is the shark playing with the fish? | c) No, they aren't. They're waiting for a boat! |
| 4. Is she phoning her mother? | d) No, he isn't. He's making a video. |

4

Read and circle *Yes, I am.* or *No, I'm not.*

- Are you making a video?
Yes, I am. / **No, I'm not.**
- Are you waiting for a bus?
Yes, I am. / No, I'm not.
- Are you writing a postcard?
Yes, I am. / No, I'm not.
- Are you learning English?
Yes, I am. / No, I'm not.
- Are you phoning your grandmother?
Yes, I am. / No, I'm not.
- Are you sitting down?
Yes, I am. / No, I'm not.
- Are you looking at your English book?
Yes, I am. / No, I'm not.
- Are you playing the piano?
Yes, I am. / No, I'm not.

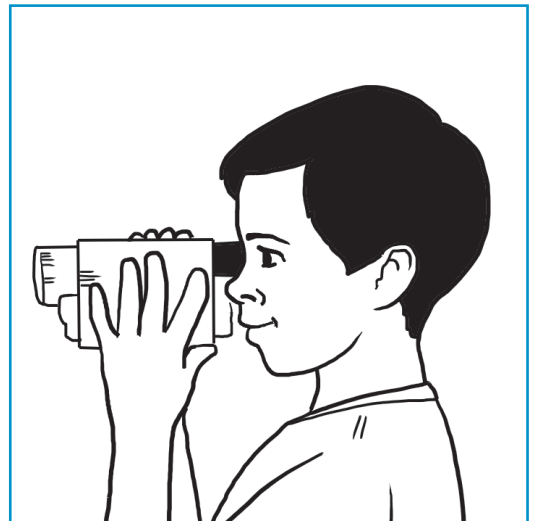

5

Trace and copy

ou ou ou ou ou

ru ru ru ru ru

four four four four

brush brush brush brush

6

Read, look and answer

1. Is Samira's mother visiting the museum?

No, she isn't . She is reading .

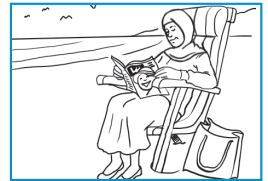

2. Is Kareem's father playing tennis?

No, _____ . He _____ .

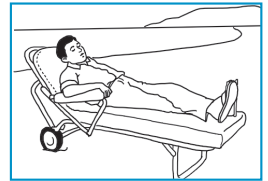

3. Is Kareem swimming?

Yes, _____ .

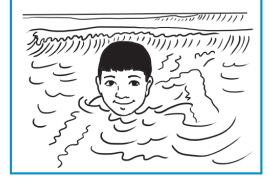

4. Is Samira writing postcards?

No, _____ . She _____ .



5. Is Grandma reading a postcard?

Yes, _____ .



7



Listen, point and say

gl pl sl

8

Look and write a postcard

Dear Grandma and Grandpa,

We're



_____!

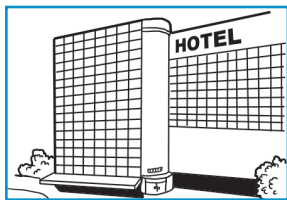

near the old city. Dad



about Petra and Mum



of the old buildings.

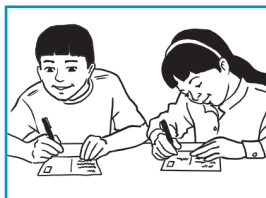

We're _____

_____!

Love,
from Samira and Kareem

We're going to visit a farm

1 Read, look and complete

tomatoes farm sun hat chickens

1. We're going to visit a farm !



2. We're going to see the _____ .

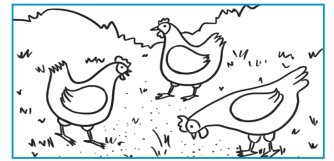

3. I'm going to plant _____ .



4. I'm going to take my _____ .

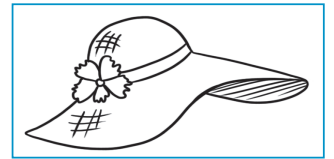

2 Read and answer

see the goats take a book about Deir Alla pick fruit take my camera
plant tomatoes take my sun hat draw pictures take my crayons

What are you going to take to the farm?

I'm going to take my camera.

What are you going to do?

I'm going to see the goats.



3 Read and circle Yes or No

Uncle Hassan has a farm in Deir Alla. Kareem and Samira are going to visit Uncle Hassan and Aunt Muna on Monday. The children are going to stay on the farm for ten days. They're going to help Uncle Hassan. They're going to plant vegetables and pick fruit. And they're going to help Aunt Muna. They're going to find the chickens' eggs! On Saturday, they're going to go to Ajloun.

1. The children are going to go to Deir Alla. Yes / No
2. They're going to visit Aunt Muna and Uncle Hassan. Yes / No
3. They're going to stay in a hotel. Yes / No
4. They're going to help Uncle Hassan. Yes / No
5. They're going to pick vegetables. Yes / No
6. They're going to plant fruit. Yes / No

4 Read, look and write answers

go to the sports centre go to the library pray at the mosque use the computer

1. What are you going to do on Sunday?

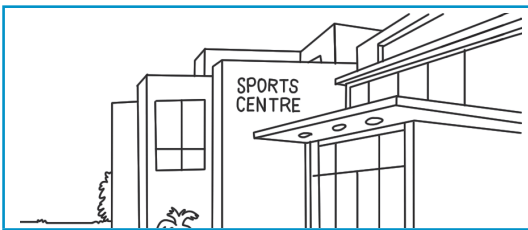

I'm going to go to the sports centre.

2. What are you going to do on Monday?



3. What are you going to do on Wednesday?

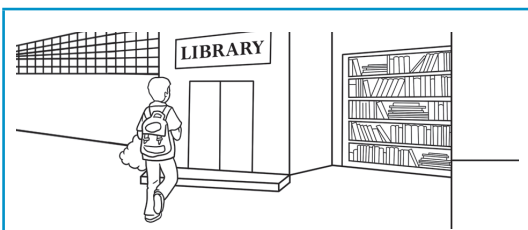

4. What are you going to do on Friday?

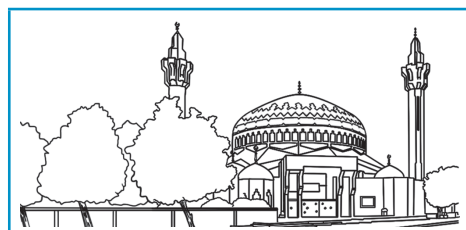

5 Write and use capitals

dear ali and laila,



Dear Ali and Laila,

deir alla is west of amman.

we're going to see the roman theatre at umm qais.

kareem and samira

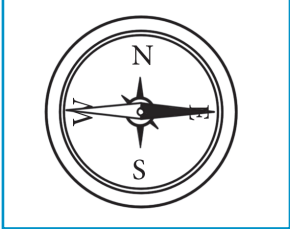
6 Look and complete

1.  2.  3.  4. 

north

7 Trace and copy

os os os os os

mosque

hospital

re re re re re

bread

dress

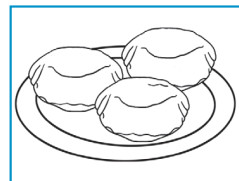

8



Listen, point and write

- 1. ice cream 2. brush 3. dress 4. breakfast
- 5. crayon 6. bread

9

Write about your friend

What is he/she going to do on Sunday?

Sunday

She's going to visit friends

Monday

Tuesday

Wednesday

Thursday

Friday

We're travelling to Ajloun today!

1 Read and match

- | | |
|--------------------------------|-----------------------------------|
| 1. We usually go to the market | a) a photo of us! |
| 2. Uncle Hassan is taking | b) to Ajloun. |
| 3. He is standing | c) the steps. |
| 4. Today we're travelling | d) at the top of the castle. |
| 5. Uncle Hassan is walking up | e) to the library at the weekend. |
| 6. We usually go | f) on Saturday. |

2 Read, look and complete

take taking walk walking

1. I usually take lots of photos.
2. I'm _____ a photo now!
3. I'm _____ up the steps to the top
of the castle now!
4. We usually _____ to school.

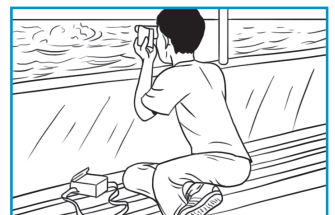
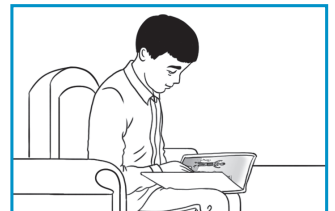

3 Read, look and write answers

1. What do you usually play after school?



I usually play football.

2. What are you playing now?

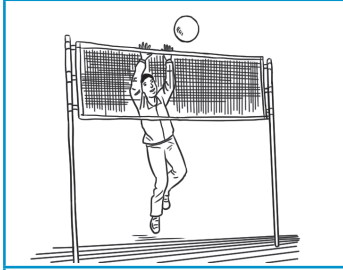

I'm playing volleyball now.

3. Who do you usually visit on Fridays?

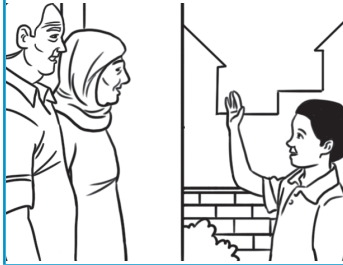

4. Where do you usually go at the weekend?

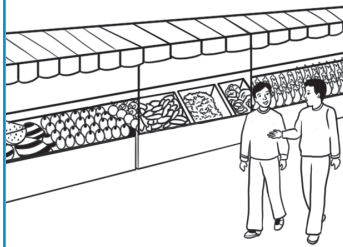

5. Where are you going now?

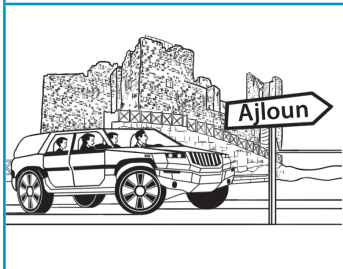

4 Read and circle Yes or No

- 1. I usually play sport at the weekend. Yes / No
- 2. I usually help my mother at home. Yes / No
- 3. I usually do my homework before school. Yes / No
- 4. I usually tidy my room at the weekend. Yes / No
- 5. I usually go swimming in the winter. Yes / No

5 Read, look and complete

gate room steps bridge top century

1. The castle is from the
twelfth century .

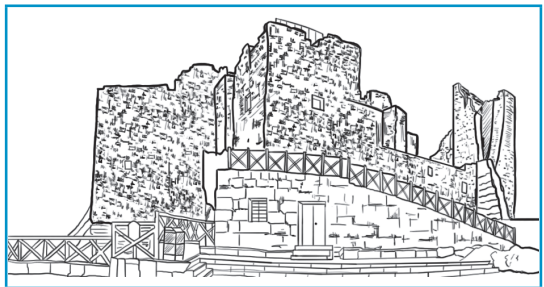

2. I'm walking across the

_____ .



3. Now I'm going through
the _____ .



4. This is my favourite

_____ in the
castle!

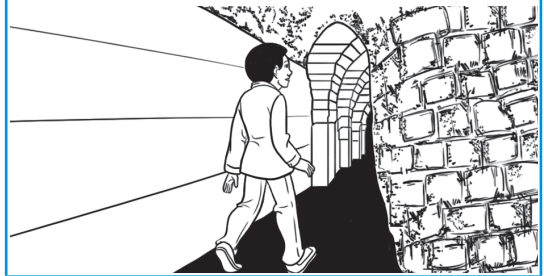

5. I'm walking up all the

_____ .

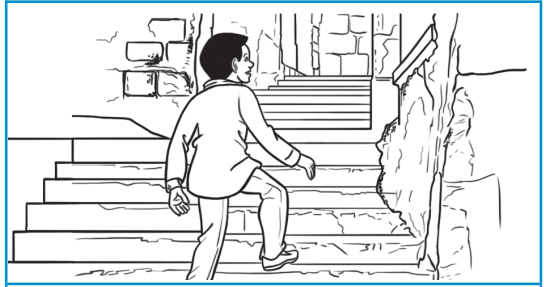

6. Now I'm looking down
from the _____ !

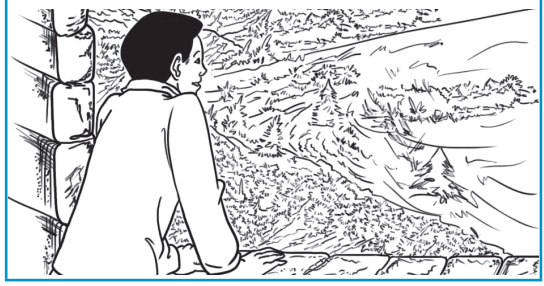

6 Trace and copy

q q q q q

mosque

j j j j j

jacket

y y y y y

pyjamas

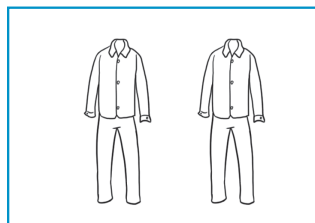

7 Read and complete

- I usually **drink** milk but today I'm drinking water.
- I usually **play** table tennis but today _____ volleyball.
- I usually **write** my diary after school but today _____ my school project.
- I usually **look down** from my window but today _____ from the top of a castle!
- I usually **travel** by bus but today _____ by car.
- I usually **walk up** the school steps but today _____ the castle steps!

8 Listen, point and say

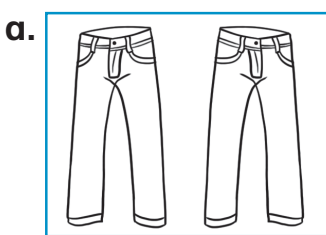

b. **12th**



Squirrels are smaller than deer

1 Look and write

What are these animals?

wolf jackal squirrel deer

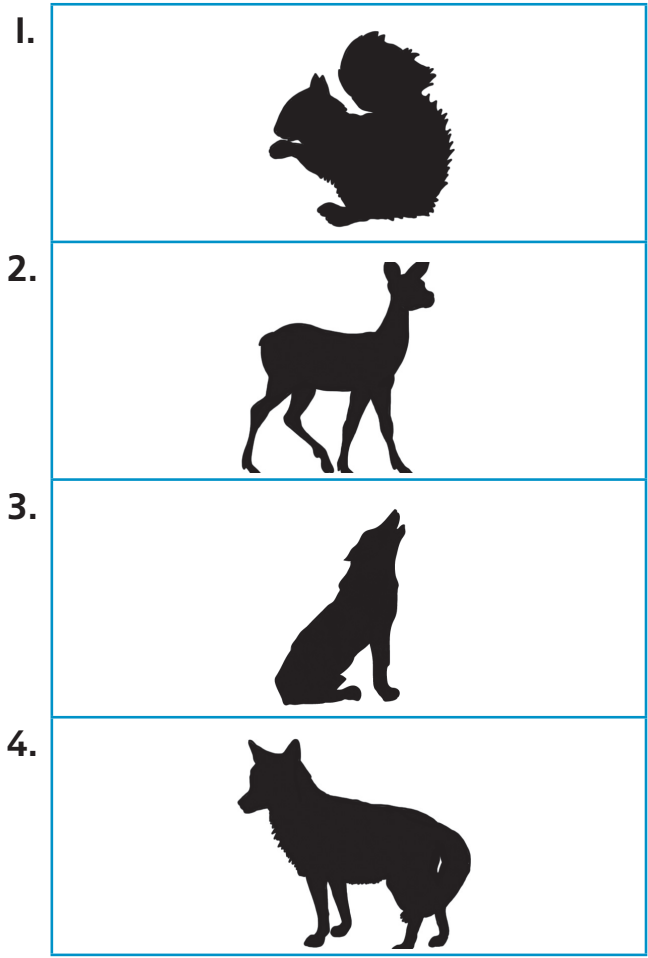

It's a squirrel.

2 Read and circle Yes or No

1. A deer is smaller than a squirrel.
2. Squirrels are smaller than jackals.
3. Squirrels are bigger than wolves.
4. A deer is faster than a squirrel.
5. A wolf is more dangerous than a squirrel.
6. A deer is bigger than a jackal.

- Yes / **No**
- Yes / No
- Yes / No
- Yes / No
- Yes / No
- Yes / No

3 Complete

- (big) A bus is bigger than a car.
- (small) An olive is _____ an apple.
- (tall) A tree is _____ a flower.
- (dangerous) A leopard is _____ a lamb.

4 Read, look and complete

The cat is bigger than the frog. It's smaller than the lion.

The elephant is (1) bigger than the giraffe.

It's bigger than the lion, the cat and the frog!

The giraffe is (2) _____ the lion,
but it's (3) _____ the elephant.

The lion is (4) _____ the giraffe,
but it's (5) _____ the cat.

The frog is (6) _____ the cat.

It's smaller than the lion, the giraffe and the elephant.

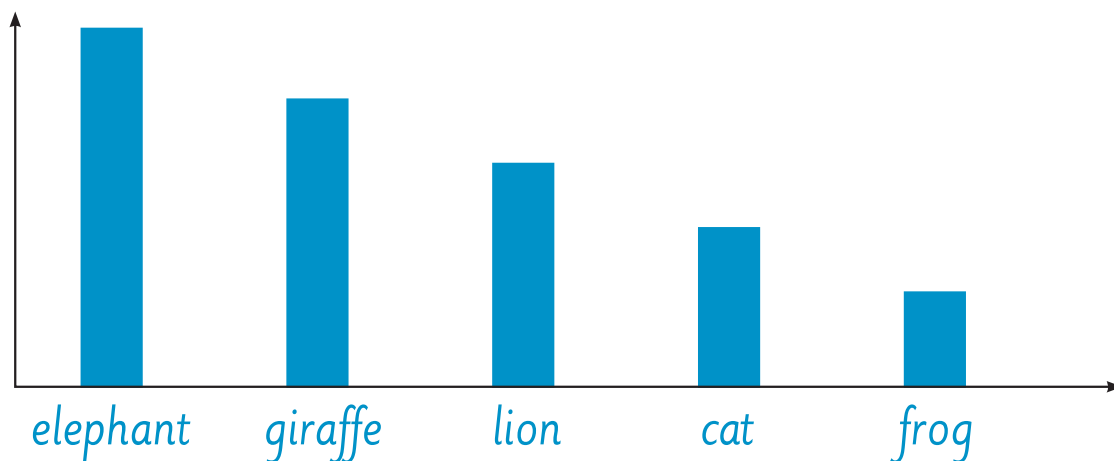

5

Trace and copy

ch ch ch ch ch

chair

watch

al al al al al

ball

walk

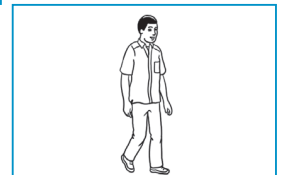
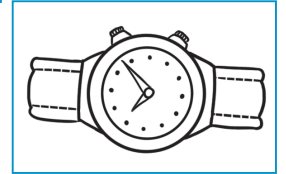
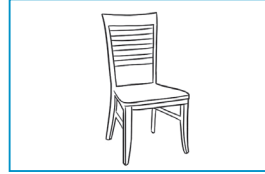

6

Read, complete and say

big frightened fast pretty small

A little deer lives in the forest. It is (1) smaller than the other deer. The other deer are (2) _____ the little deer. It can run fast, but the other deer can run (3) _____ it can.

People walk in the forest in the spring. In the spring, the flowers are (4) _____ in the autumn. The little deer is frightened of people. It is (5) _____ of people than the other deer.

7



Listen and point

1. fr frog

2. gr green

3. pr pretty

8

Look and complete

tall small old young

I'm 11!

I'm 10!

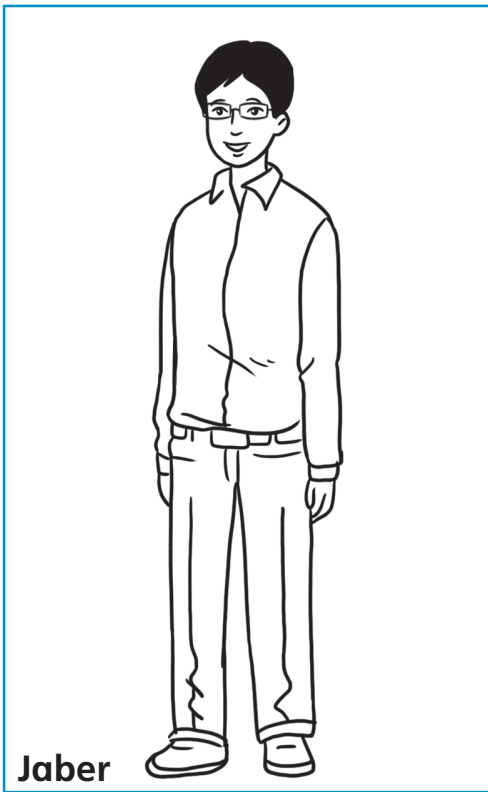

Jaber



Rakan

1. Jaber *is taller than* Rakan.

2. Rakan _____ Jaber.

3. Jaber _____ Rakan.

4. Rakan _____ Jaber.

Review

1 Read, look and complete

planting at the top picking going to have
looking down across making walking up



1. We usually go to the library on Friday, but today we're picking fruit on a farm!

2. The apples are _____ of the tree.

3. I'm _____ the ladder.

4. Now I'm _____ at Samira!

5. Uncle Hassan is walking _____ the garden.

He's _____ flowers.

6. Aunt Muna is _____ a video.

7. After we pick the apples, we're _____ a picnic in the garden!

2 Write

On Friday I'm _____

and I'm _____.

On Saturday I'm _____

and I'm _____.

What are you going to do at the weekend?

3



Listen, read and circle Yes or No

- 1. I'm visiting a twelfth century castle now. Yes / **No**
- 2. I usually play the piano at the weekend. Yes / No
- 3. I'm taking my sun hat tomorrow. Yes / No
- 4. We usually stay in a hotel in the holidays. Yes / No
- 5. We're travelling west now. Yes / No
- 6. We're watching the dolphins! Yes / No
- 7. We're waiting for the boat now. Yes / No
- 8. I'm writing my postcards now! Yes / No

4

Read and say

1. glass *gl*

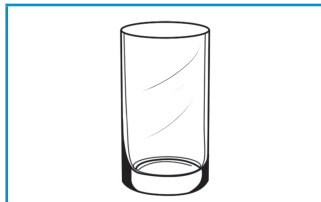

6. crayon *cr*

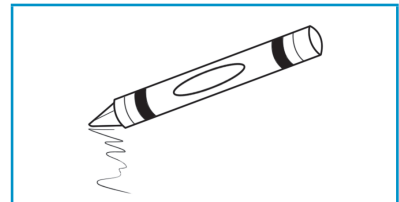

2. plant *pl*



7. dress *dr*



3. sleep *sl*

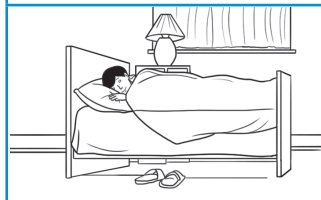

8. tree *tr*



4. bridge *br*



9. twelfth *tw*



5. frog *fr*



10. present *pr*

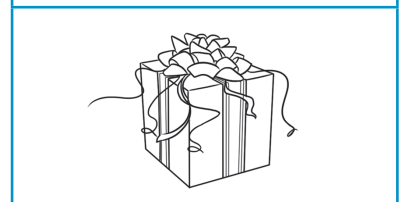

5

Read and match

What do they do?

Where do they work?

What are they doing today?

He's a chef.

He works in an airport.

She's teaching her class now.

She's a teacher.

She works in a hospital.

He's cooking a delicious lunch today!

He's a pilot.

He works in a restaurant.

She's helping a child with stomachache now.

She's a doctor.

She works in a school.

He's flying a plane now.

6



Listen and write

1 *It's small and grey.*



2

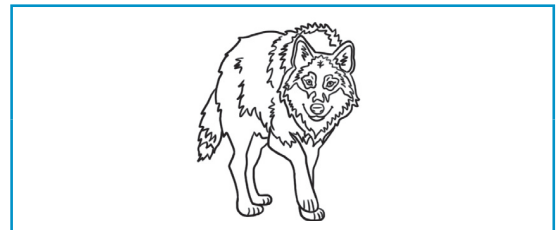

7

Read and answer

Which animal is more dangerous, the squirrel or the wolf?

Handwriting lines for the answer.

1 Read and match

- | | |
|--|---|
| 1. Let's go to the planetarium tomorrow. | a) The sky is darker. You can see the stars. |
| 2. This is the hottest planet. | b) It's very light in the museum. |
| 3. Why are the stars brighter on the farm? | c) You can learn about the stars and planets there. |
| 4. How are we going to see the stars? | d) You can't make a snowman here! |

2 Read, look and complete

biggest hottest darkest brightest

1. This is the
 brightest star.

2. This is the
_____ planet.

3. This is the
_____ planet.

4. The planetarium is the
_____ room
in the museum!

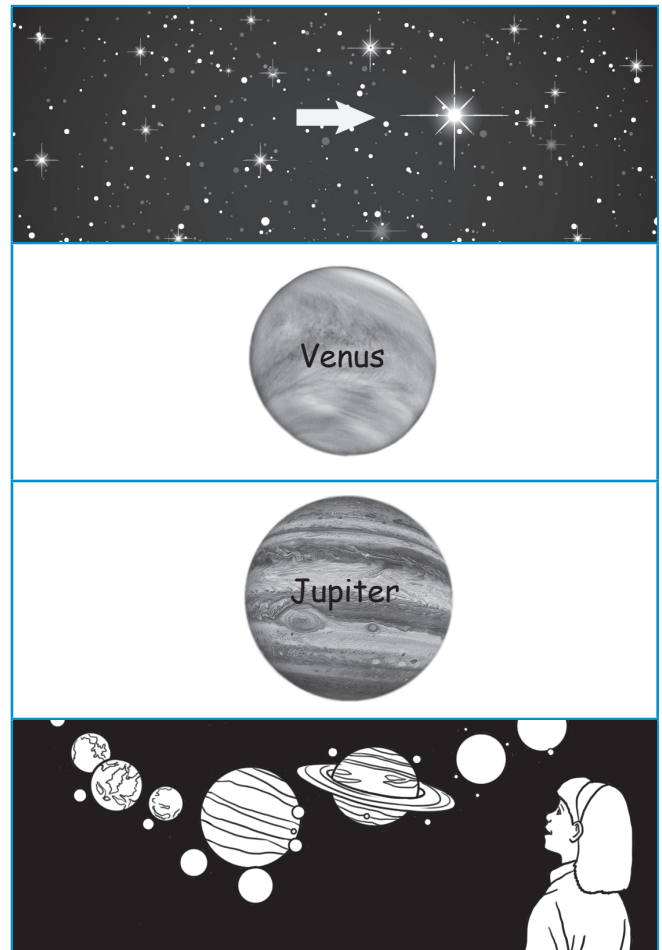

3 Read and write

brightest darkest hottest coldest

- 1. July [bright] is the brightest month .
- 2. August [hot] _____ .
- 3. December [dark] _____ .
- 4. January [cold] _____ .

4 Read, look and complete

- 1. Amman is the biggest city in Jordan.
- 2. Jerash is the smallest city in Jordan. Jerash is smaller than Aqaba.
- 3. Irbid is smaller than Zarqa and bigger than Aqaba.

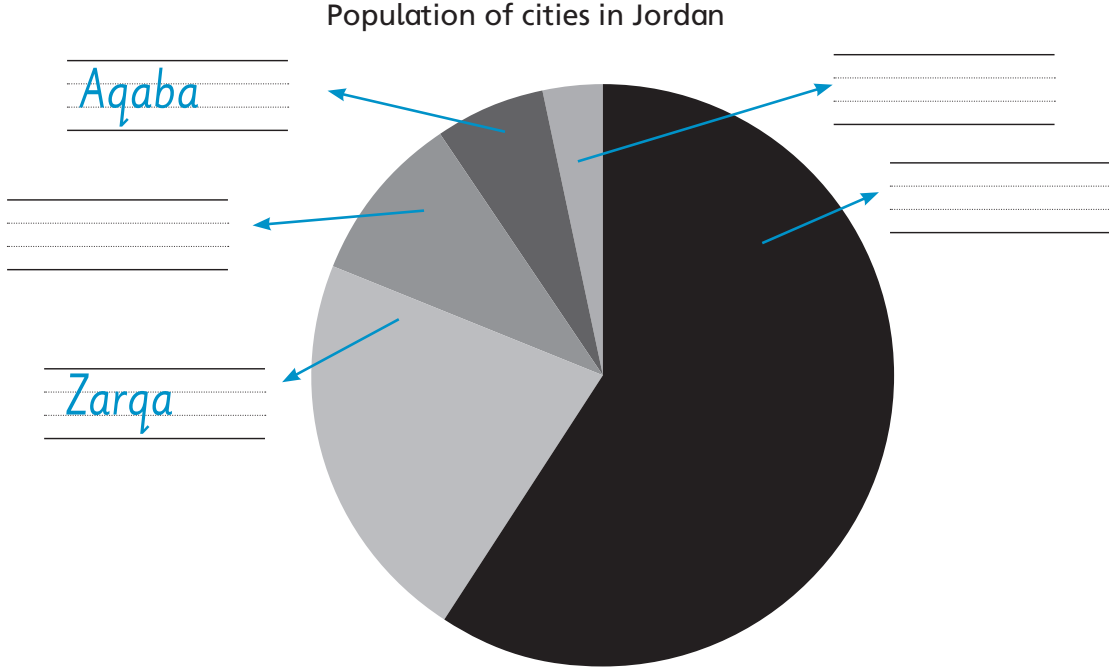

5

Trace and copy

ab ab ab ab ab

table

baby

nt nt nt nt nt

elephant

present

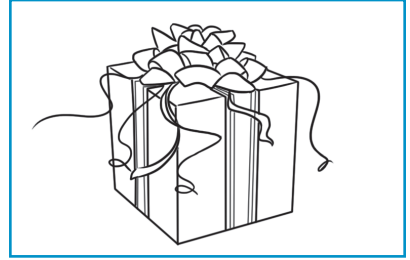
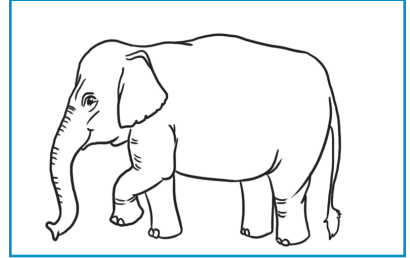
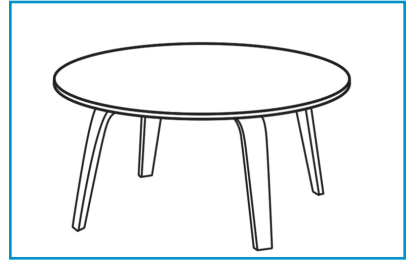

6

Read and answer

1. Where is your favourite museum?

2. What can you see in the museum?

3. What is in the biggest room in the museum?

4. What is in the smallest room in the museum?

7 Read and circle *Yes* or *No*

- 1. The moon goes around the Earth. Yes / No
- 2. The planets go around the sun. Yes / No
- 3. The sun is a planet. Yes / No
- 4. We live on the planet Earth. Yes / No
- 5. When it's day time in Jordan,
it's night time on the other side of the Earth. Yes / No
- 6. It's light at night and dark in the day. Yes / No
- 7. The Earth turns around once a day. Yes / No

8  Listen and number

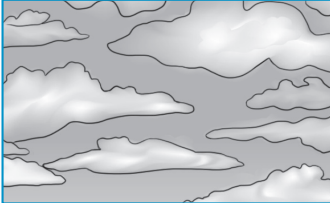
sky 

snowman 

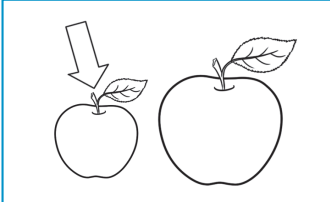
small 

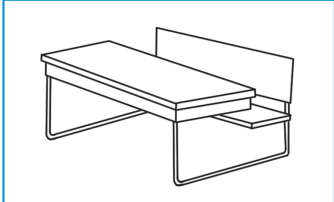
desk 

snowy 

skirt 

Our city wasn't called Amman

1

Read and match

- | | |
|--|---|
| 1. Was the stage here? | a) Yes, there were. |
| 2. Were there people here? | b) Yes, but they were smaller than me! |
| 3. Were these trees here when you were young, Dad? | c) No, it wasn't. It was called Philadelphia. |
| 4. Was our city called Amman in the past? | d) Yes, it was. |

2

Read, look and complete

fountain pool stage street

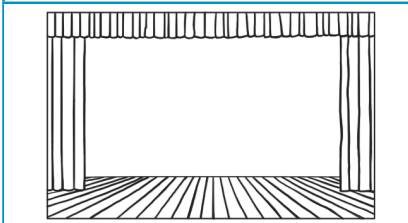
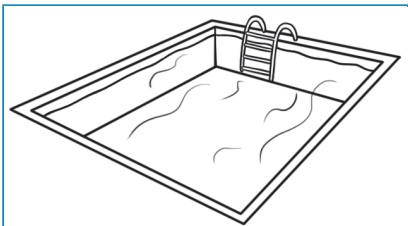

- In the past, there was a pool here.
- The theatre was bigger in the past. The _____ was here.
- There was a big _____ in the old city.
- This _____ was a river!

3 Copy and complete the punctuation

, .

- 1. In the past this street was very different
In the past, this street was very different.
- 2. In the past the hotel wasn't here it was a park
- 3. In the past this wasn't a museum it was a baker's
- 4. In the past the shops weren't here
- 5. In the past this wasn't a school it was a hospital

4 Read and order

- a) There were big forests in Jordan.
- b) The weather was different in Jordan.
- c) In the forests there were tall trees, rivers and pools.
- d) The weather wasn't hot and dry.
- e) Now the weather is hotter and drier.

5 Look and write the differences



1. In the past, *the houses were smaller.*
2. The castle
3. The fountain
4. There were

6 Trace and copy

op op op op op

people

top

oy oy oy oy oy

boy

toy

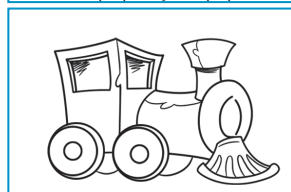
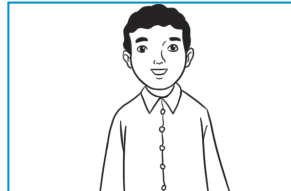

7



Listen, point and say

speak stork stadium spring
steps stamp swim sweet

8

Write *was* or *wasn't*

When I was a baby...



1.

very pretty!



2.

always happy.



3.

very big.



4.

always hungry.

We visited a museum

1 Look and match

1. a tent

2. the desert

3. bread

4. coffee

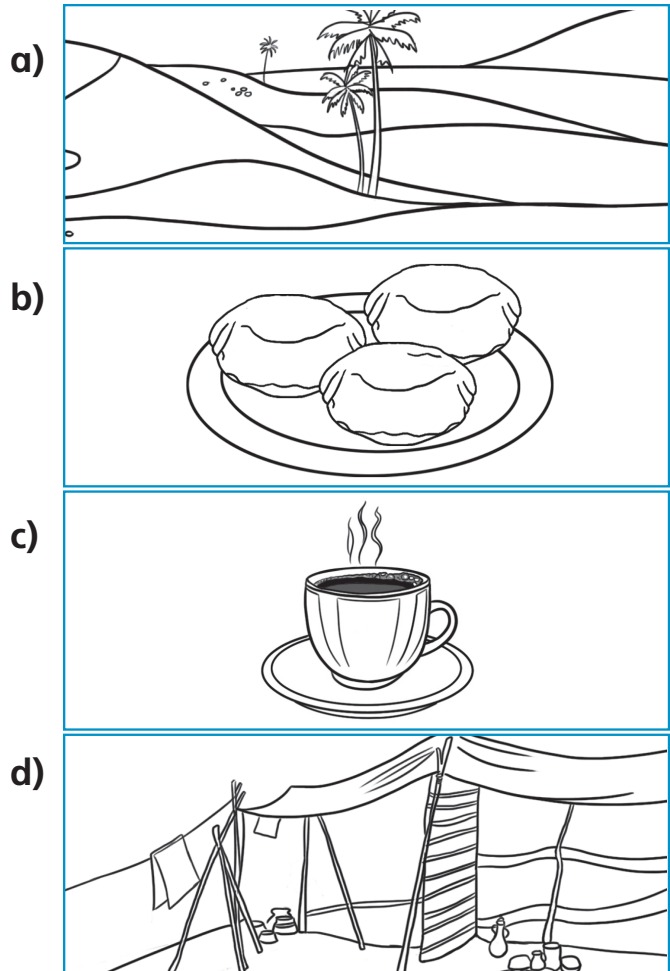

2 Read and complete

used visited learned liked lived sewed

1. I liked school today.

2. We _____ a museum.

3. We _____ about how people _____ in the past.

4. The women _____ beautiful clothes.

They _____ goats' hair for the tents!

3

Read and complete

in the morning in the evening in the afternoon

1. Yesterday, Dad cooked a delicious breakfast in the morning.

2. I helped my teacher at school _____.

3. I played with my friends in the park _____.

4. I watched television with Mum and Dad _____.

4

Look and write

Yesterday...

learned helped played visit

1. I visited my grandmother.

2. _____

3. _____

4. _____

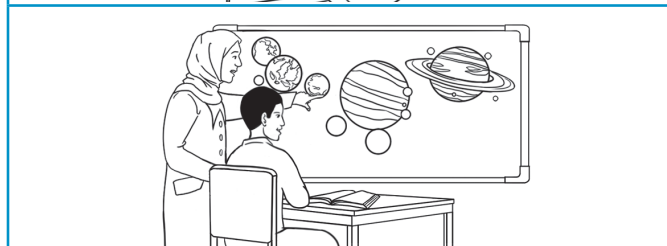
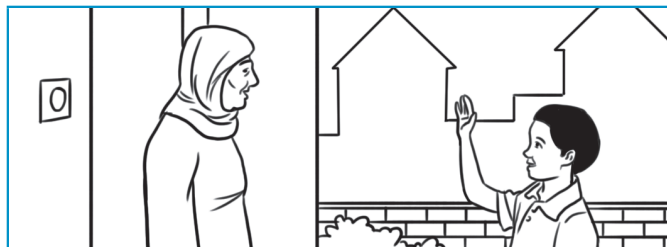

5 Suggest a title for the story

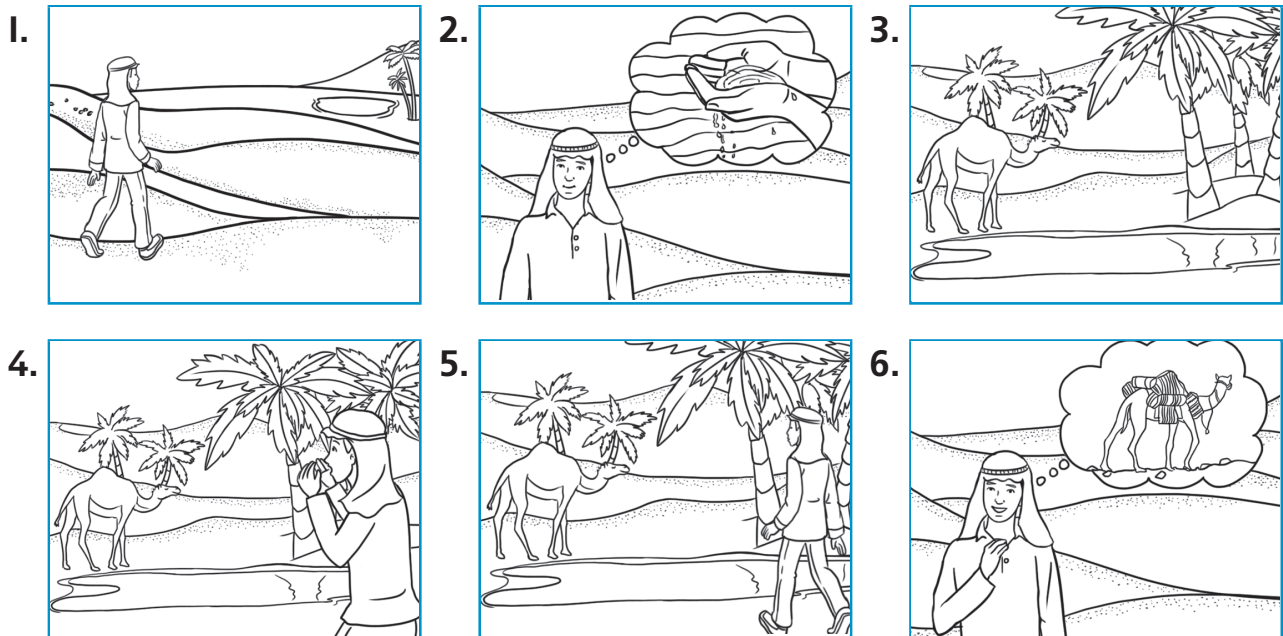

6 Trace and copy

he he he he he

head

chef

da da da da da

dad

Jordan

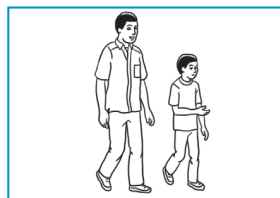

7



Listen, read and say

1. a pink balloon
2. This lamb is ill.
3. a small hill
4. Thank you!

8

Read and circle Yes or No

Fatima was happy at the weekend. She helped her mother make breakfast at eight o'clock. She brushed her teeth and washed her hands at half past eight. The family walked to the beach at a quarter past nine. She talked to her friends at the beach in the morning and her brothers played football.

1. Fatima was sad at the weekend. Yes / **No**
2. Fatima helped her mother in the morning. Yes / No
3. She brushed her teeth and washed her hands before breakfast. Yes / No
4. The family walked to the beach at a quarter past nine. Yes / No

9

Say and write

1. *I* or *eye*? I like apples.

Go to sleep, baby! Close one eye. Now close two eyes!

2. *here* or *hear*? Listen ! I can _____ a wolf!

I'm looking for Nadia. Is she _____ ?

3. *to* or *two*? I'm going _____ the park with my friends.

What's the time? It's _____ o'clock.

1 Read and match

- | | |
|---|---|
| 1. We were at a museum. | a) The Children's Museum is new. |
| 2. We visited the planetarium. | b) We learned about how people lived in the past. |
| 3. In Amman, there are lots of new buildings. | c) when Mum and Dad were young. |
| 4. It wasn't there | d) We learned about the stars and the planets. |

2 Read, look and write answers

planetarium forest stage street

1. Where was Kareem at the weekend?

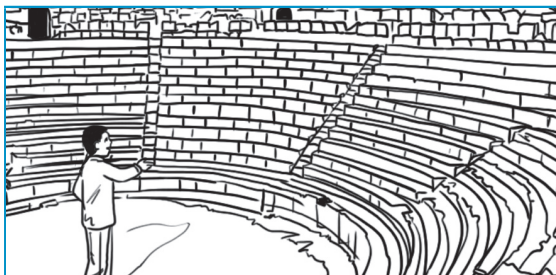

He was on the stage of the Roman Theatre.

2. Where was Samira on Saturday?



3. Where was Kareem on Friday?



4. Where was Samira on Sunday afternoon?



3 Read and say

1. ball



2. grapes



3. drink

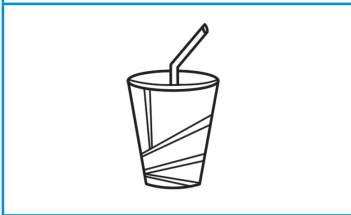

4. desk

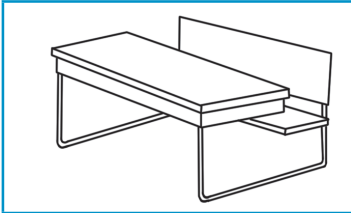

5. small

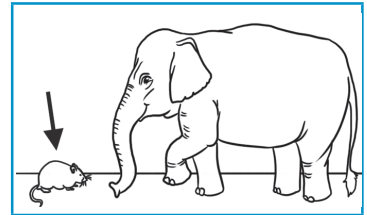

6. snowman



7. sports centre



8. street



4 Look and complete

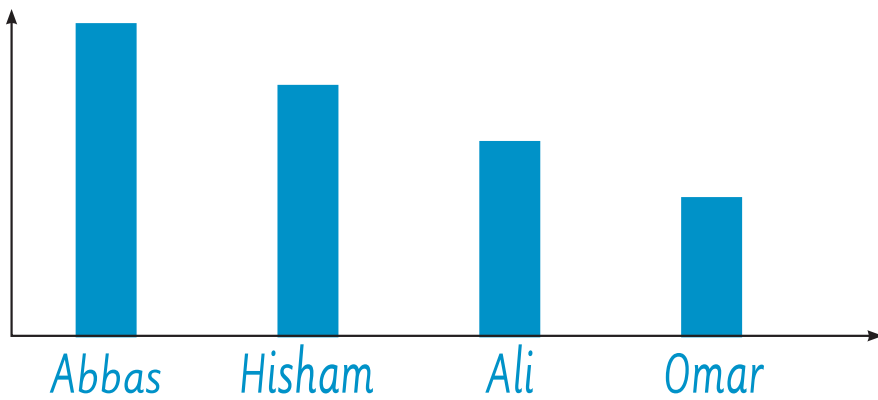

tall short

1. Abbas is the _____

2. Omar is the _____

3. Hisham is _____ Ali.

4. Omar is _____ Hisham.

5 Read and tell the story

winter animals / hungry wolf / jackals / squirrels / hungry
days / cold nights / dark wet / rainy
moon / different brighter beautiful stars / brighter
warmer animals / happy spring!

It was winter. All the animals in the forest were hungry. The wolf, the jackals and the little squirrels in the trees were hungry. The days were cold and the nights were dark. It was very wet and rainy.

One night, the moon was different. It was brighter. It was more beautiful. The stars were brighter too. It was warmer. The animals were happy because it was spring!

6 Look, listen and tell the story

Last month, Omar visited his grandparents. He arrived in the afternoon.

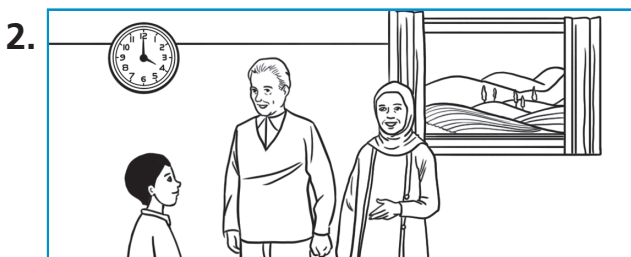
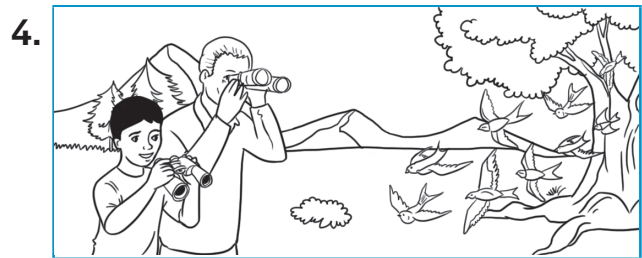
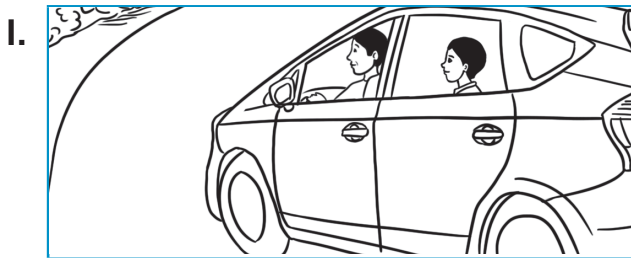

Unit
14

We didn't live in a city

1 Look and write

1. *a CD*

2.

3.

4.

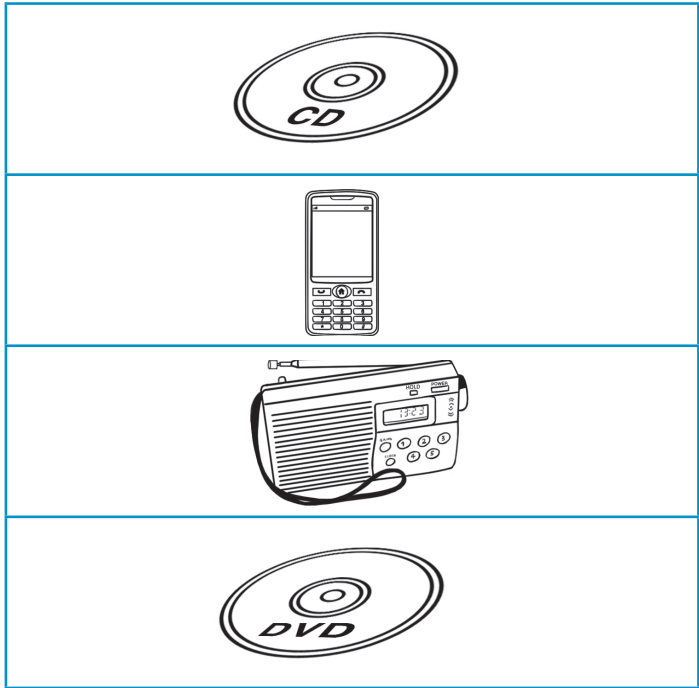

2 Look and write



When we were young...

1. mobile phones

we didn't use mobile phones.

2. radio

3. DVDs

4. CDs

3 Read and circle *True* or *False*

In the past some people didn't live in villages, they lived in the desert. They didn't live in houses in the desert, they lived in tents. They didn't have cars, they used camels to travel.

In the past people didn't have mobile phones or computers. They didn't go to sports centres and they didn't watch television or listen to the radio. They didn't go on holiday and their children didn't have bicycles and lots of toys. The girls played with dolls. They watched the stars and they talked.

- | | |
|---|---|
| 1. In the desert, people didn't live in houses. | <input checked="" type="radio"/> True / <input type="radio"/> False |
| 2. The children listened to the radio. | <input type="radio"/> True / <input type="radio"/> False |
| 3. They watched television. | <input type="radio"/> True / <input type="radio"/> False |
| 4. The girls played with dolls. | <input type="radio"/> True / <input type="radio"/> False |
| 5. They didn't go on holiday. | <input type="radio"/> True / <input type="radio"/> False |

4 Look and write

I was ill yesterday. I didn't enjoy my day in bed!

1. *I didn't go to school.*
- 2.
- 3.
- 4.

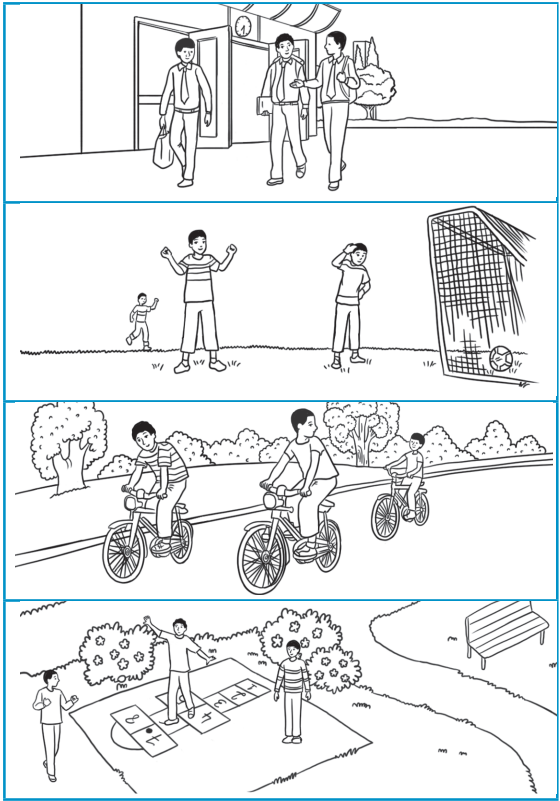

5

Look and write

look stay travel laugh

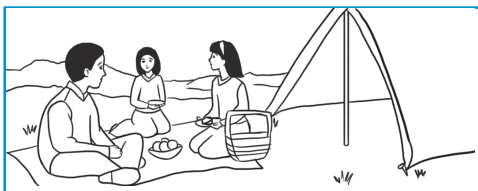

We stayed in a tent in Wadi Rum.

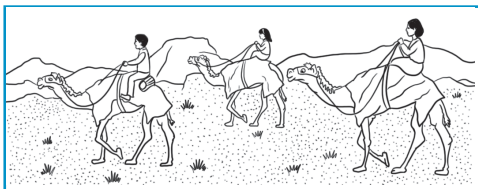

6

Trace and copy

la la la la la

flag

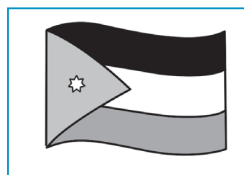

salad



be be be be be

bed

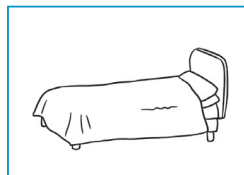

bear



7



Listen, point and say

sock clock chicken jacket laugh

8

Read and answer about you

1. You listened to a CD last week.

No, I didn't listen to a CD last week.

2. You watched tennis last week.

Yes, I watched tennis last week.

3. You listened to the radio last week.

4. You travelled to Wadi Rum last year.

9

Read and match

1. Father

a) Grandpa

2. Mother

b) Grandma

3. Grandfather

c) Mum

4. Grandmother

d) Dad

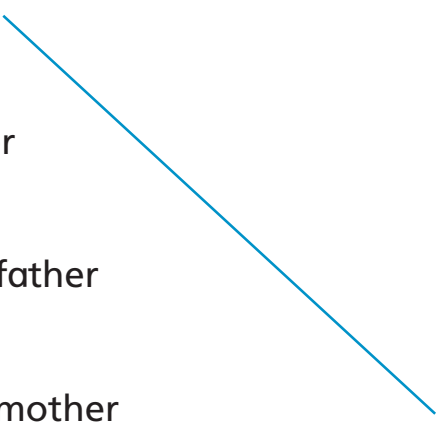

Unit
15

What time did you arrive?

1

Look and write

a tunnel a canyon a rock



a. *a tunnel*

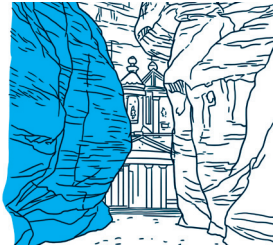

b. _____



c. _____

2

Look and complete

1. What time did you arrive?



*We arrived at eleven
o'clock*

2. How did you travel?



3. What did you learn about?



4. Where did some people live?



3 Copy and write ? or .

1. How did you travel
How did you travel?

We travelled by car

2. Where did you stay

We stayed in a hotel

3. What did you visit

We visited a cave

4 Write questions

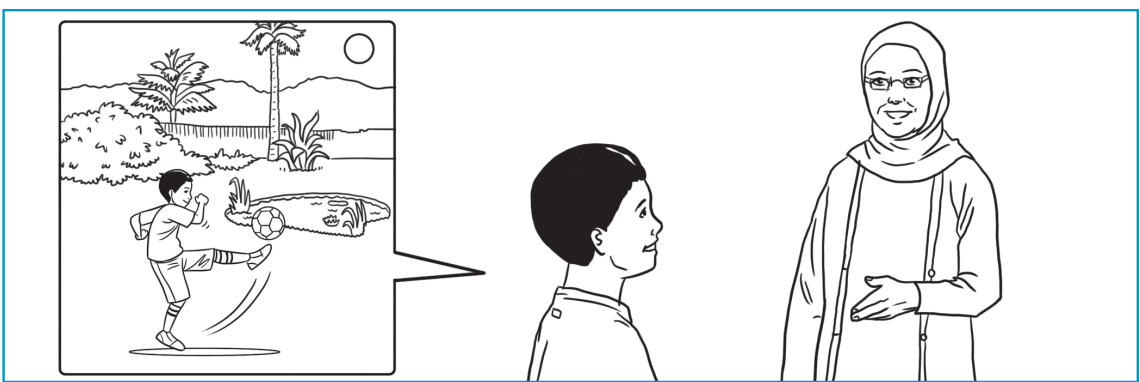

1. What did you do yesterday?

I played football.

2.

I played in the park.

3.

I played in the afternoon.

5

Order and write the answers

- 1 visited We Petra.
- 2 by travelled We car.
- 3 in stayed a We hotel.
- 4 looked caves. the We at

1. Where did you go in the holidays?

We visited Petra.

2. How did you travel there?

3. Where did you stay?

4. What did you do?

6

Trace and copy

rd rd rd rd rd

bird



card



ol ol ol ol ol

olive

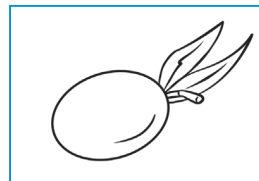

doll



7



Listen and write

bottom

summer

tunnel

tennis

8

Write questions

what / do / yesterday where / go / last week
how / travel / to Irbid

- 1. What did you do yesterday? I did my homework.
2. We went to Aqaba.
3. We travelled by car.

9

Read the poem and tick

My favourite hat is yellow
My favourite dress is blue
My favourite meal is chicken
And my favourite friend is you!

This poem is about:

The clothes the poet likes.

[]

What the poet likes to eat.

[]

What the poet likes.

[]

I found an old coin

1 Read and match

1. We drove to Madaba.

a)



2. We saw the mosaics.

b)



3. I found a coin.

c)



4. We took it to the museum.

d)

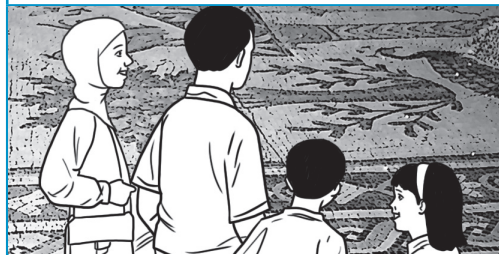

2 Read and complete

sent wrote took spoke drove found

I (1) found a small black cat in the garden yesterday. It was in a

tree. I (2) _____ the cat to my mother. She looked at the cat.

'That's my friend Ghada's cat!' We (3) _____ to Ghada's house.

We (4) _____ to Ghada. 'Is this your cat?' 'Yes! Thank you very

much!' Ghada was very happy. She (5) _____ us a letter and

(6) _____ us a photo of her cat!

3

Look and write

went/Madaba went/museum
bought/postcards had/meal/restaurant

1.

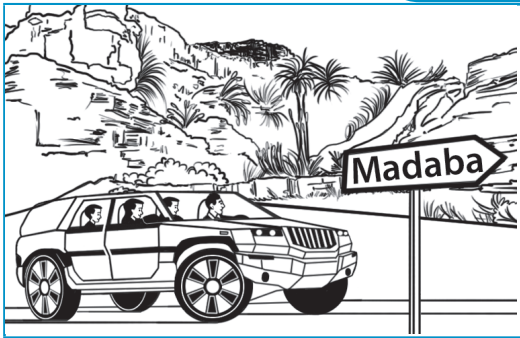

We went to Madaba.

2.

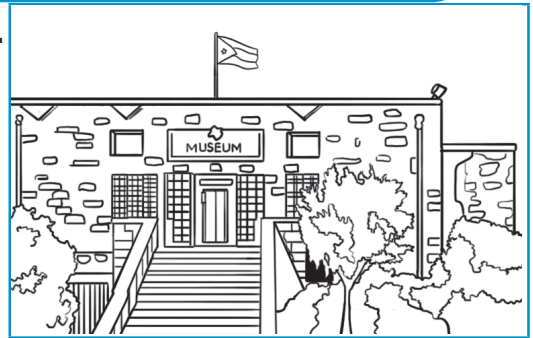

3.



4.

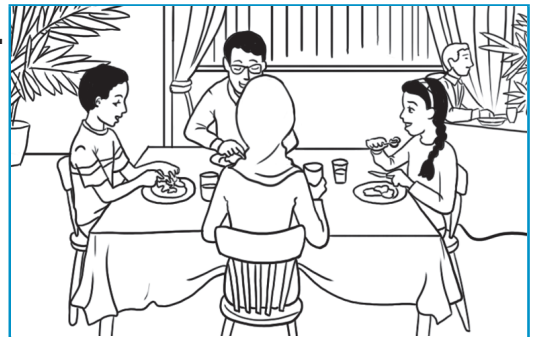

4

Look and write

1.



I went to the shops last weekend.

2.



3.



5 Write with capital letters

dear grandma and grandpa,

Dear Grandma and Grandpa,

last week, we went to madaba and umm ar-rasas.

we saw the mosaic map.

we saw the bridges over the river jordan.

kareem and samira

6 Trace and copy

ig ig ig ig ig

fig

tiger

pe pe pe pe pe

pen

grape

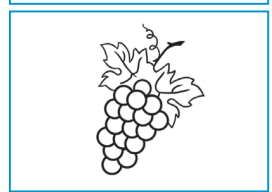
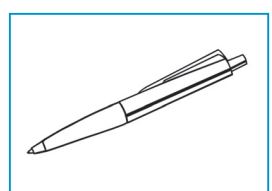
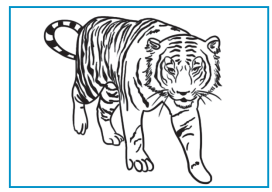
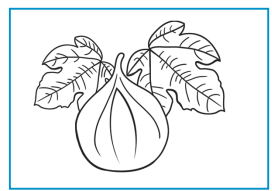

7



Listen and write

ph wr kn

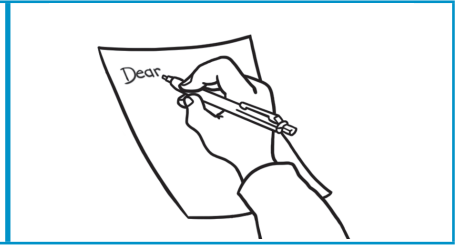
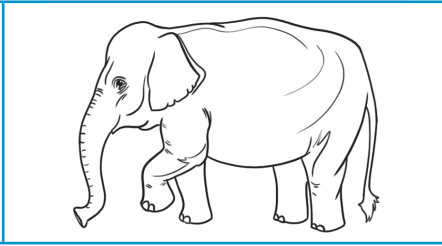
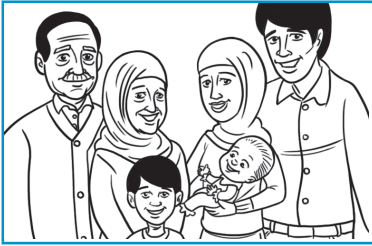
1. ph _____ oto

2. ele _____ ant

3. _____ ite

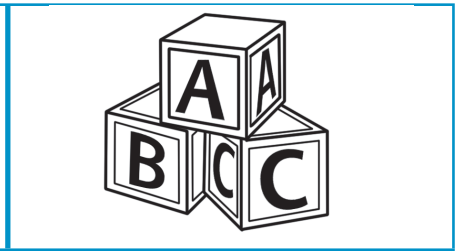
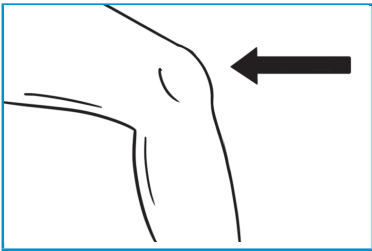

4. _____ ee

5. _____ one

6. al _____ abet

8

Read and circle Yes or No

Abla and her family drove to Theban at the weekend. They saw the women of Bani Hamida. Abla took some photos and her mother bought a colourful rug. The family had lunch in a restaurant. In the afternoon, they went up the hill and saw the castle. They bought some postcards and they went home.

In the evening, Abla wrote a postcard about her trip to Theban. She sent it to her grandmother. She enjoyed her day!

1. Abla went to the beach at the weekend. Yes / **No**
2. Abla took some photos. Yes / No
3. Abla's mother bought a colourful bag. Yes / No
4. The family had a picnic lunch. Yes / No
5. They saw mosaics in the afternoon. Yes / No
6. Abla bought some postcards. Yes / No
7. She wrote a postcard in the evening. Yes / No
8. She sent the postcard to her aunt. Yes / No

Unit
17

Plants must have water

1

Look and complete

a hole the plant a leaf the root the ground

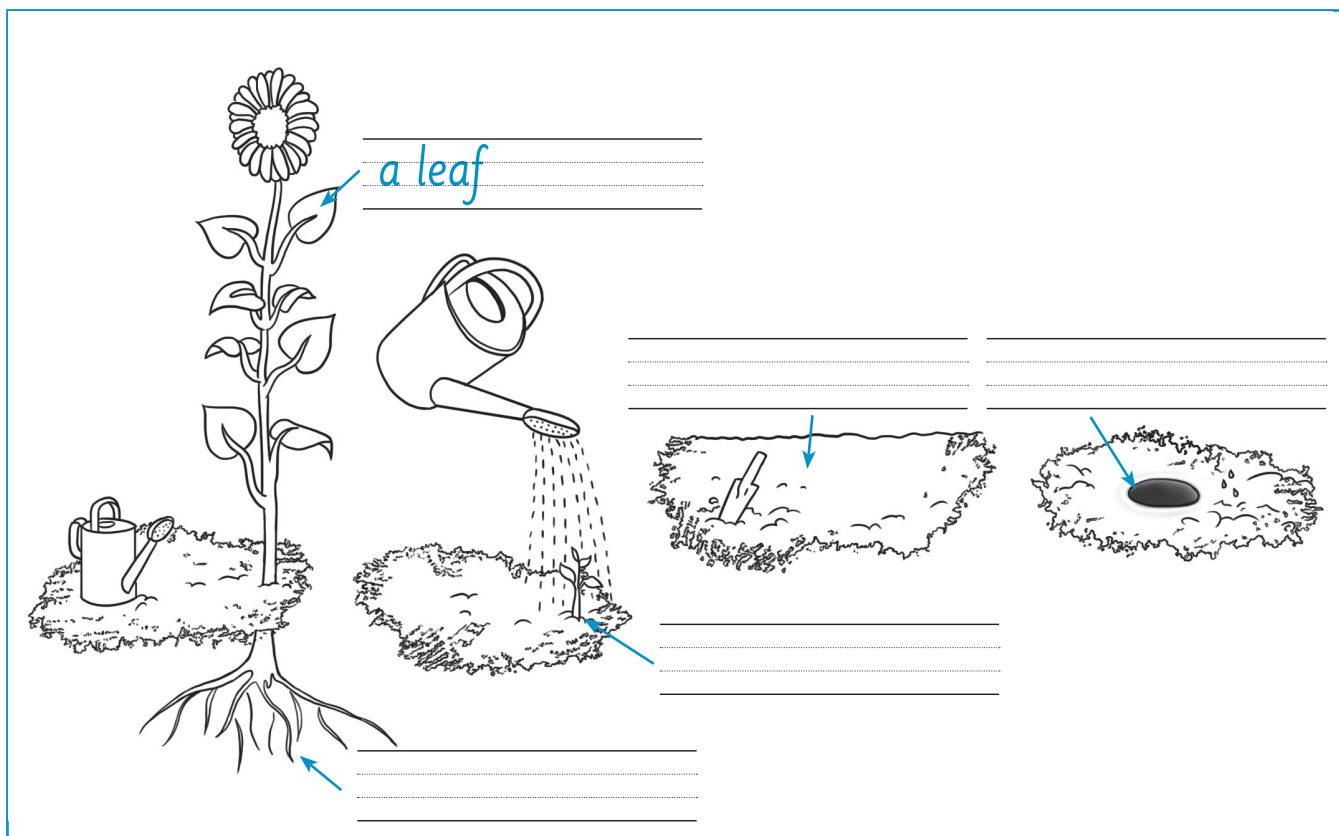

2

Read, order and write

You must wait for the tree to grow.
You must water the plant.
~~First, you must dig a hole.~~
You must put the plant in the ground.

First, you must dig a hole.

3 Read and circle *must* or *mustn't*

How to grow aubergines

1. You **must** / **mustn't** dig a hole for the aubergine plant.
2. You **must** / **mustn't** put the plant in the hole carefully.
3. At first, you **must** / **mustn't** water the plant.
You **must** / **mustn't** forget.
4. You **must** / **mustn't** wait for the aubergines to grow.
5. You **must** / **mustn't** pick the small aubergines.
6. You **must** / **mustn't** wait for the aubergines to be big and black.

4 Read, look and write answers

I'm learning to sail!

1. Do I have to sit down in the boat?



Yes, you *must sit down.*

2. Do I have to be with my parents?

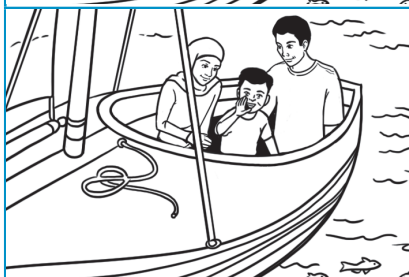

Yes, you *have to be with your parents.*

3. Do I have to take my sunglasses?



No,

4. Do I have to take this jacket?



Yes,

5

Match and make a poster for Tree Day

On the poster you must write:

- 1. Tree Day
 - 2. Trees are important:
 - 3. They are homes for
 - 4. You must take
 - 5. Your class must
- a) many animals and birds.
 - b) a spade to school.
 - c) is on 15th January.
 - d) plant a tree.
 - e) they give us wood, paper and shade.

6

Trace and copy

ap ap ap ap ap

apple

grape

ng ng ng ng ng

orange

sunglasses

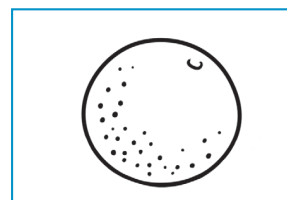
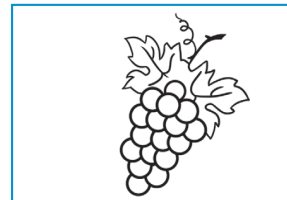
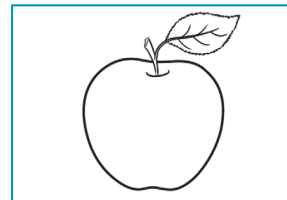

7



Listen, point and write

| |
|--------|
| square |
| square |

| |
|--------|
| spring |
| _____ |
| _____ |
| _____ |

| |
|----------|
| straight |
| _____ |
| _____ |
| _____ |

8

Read and complete

must mustn't

1. You must do your homework every day.

You musn't forget!

2. You _____ talk to your friends in class, you _____

listen to the teacher.

9

Say and write

1. for or four?

This present is for you!

One, two, three four!

2. see or sea?

Look! I can _____ a dolphin!

The dolphin is jumping in the _____!

3. right or write?

Does the Earth turn around the sun? Yes, that's _____.

I usually _____ my diary in the evening.

Unit 18

Review

1 Read, look and write answers

1. Where did you go last week?



We went to Madaba.

2. What did you see?

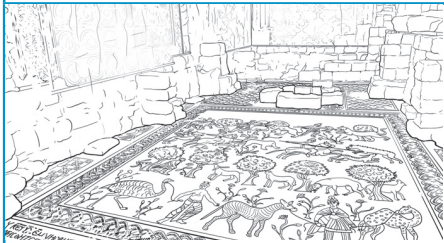

3. Where did you plant the tree?

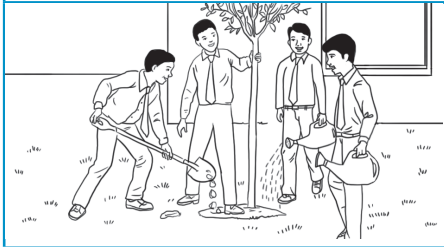

2 Read and complete

must don't have to

In the summer holidays...

1. I must take my sun hat to the beach.
2. I _____ go to school.
3. I _____ help my mother with the cooking.
4. I _____ write my project.
5. I _____ clean my room.
6. I _____ do my homework.

3



Listen, look and write

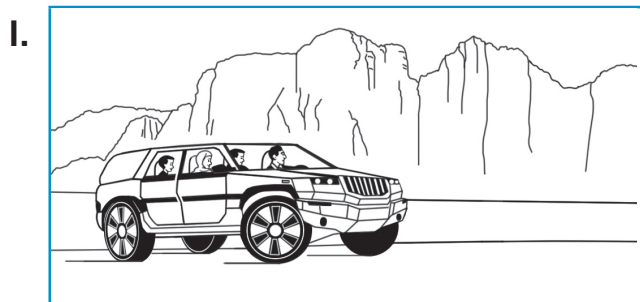

We drove into the desert.

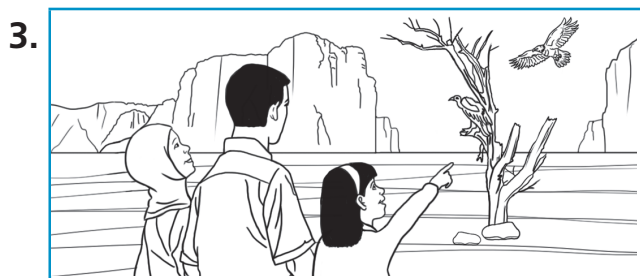

4

Order and write

1 When did the people of Petra arrive?
last / didn't / year / arrive. / They

They didn't arrive last year.

arrived / They / past. / in / the

They arrived in the past.



2 Where did the people of Petra live?
live / in / didn't / They / houses.

in / They / tents. / lived

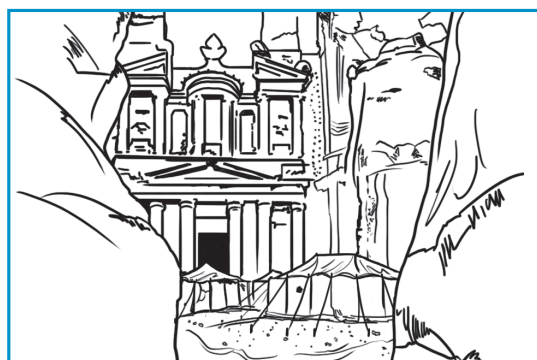

5 Read and say

1. knee

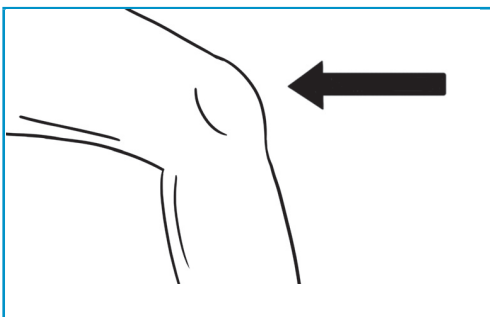

5. spring



2. photo

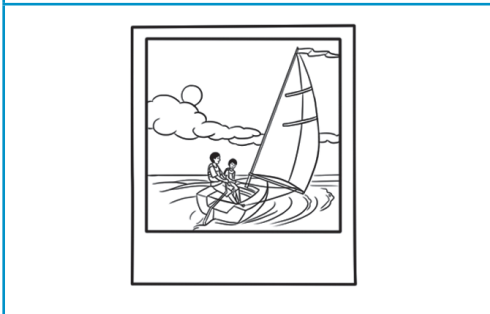

6. square

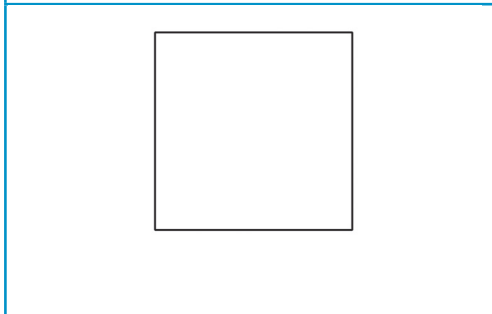

3. lamb

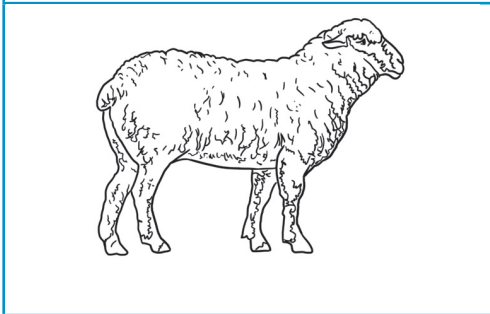

7. straight on



4. write

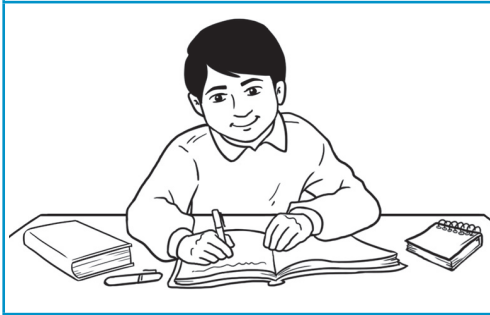

8. laugh

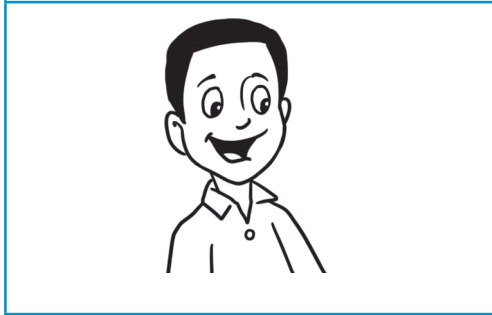

6 Write about your favourite project

Alphabet Practice

A a

B b

C c

D d

E e

F f

G g

H h

I i

J j

K k

L l

M m

N n

O o

P p

Q q

R r

S s

T t

U u

V v

W w

X x

Y y

Z z

Numbers Practice

Read, order and write

23 25 22 26 29 27 24 28

Read and complete

10 _____ 30 _____ 50 _____

Read, order and write

90 70 100 60 80 50

Read and write

15th *the fifteenth* _____

16th _____

17th _____

18th _____

19th _____

20th _____

Handwriting Practice

Aa Bb Cc Dd Ee Ff Gg Hh Ii Jj Kk Ll Mm Nn

Oo Pp Qq Rr Ss Tt Uu Vv Ww Xx Yy Zz

What is your favourite subject?

My favourite subject is Islamic Education.

Do you play table tennis?

Yes, I do. I like playing table tennis.

Are you looking at the fish in the sea?

Yes, we are! There are thirty fish!

What are you going to do on Thursday?

I'm going to pray at the mosque.

What do you usually do at the weekend?

I usually play table tennis but today I'm playing volleyball.

Amman is the biggest city in Jordan.

Yesterday, Omar visited his grandparents in the afternoon.

Where did you go in the holidays?

We visited Petra.

Do I have to do my homework every day?

Yes, you must do your homework every day!

When did you go to the library?

I went to the library on Saturday.

We drove into the desert to watch the birds.

Assessment

Unit 4 Review

What did I learn in Units 1–3 and what can I now do?

| |
|---|
| Listen to a conversation related to school |
| Listen to a conversation about playing sports |
| Speak about actions |
| Talk about sports |
| Pronounce words with the sounds <i>ch, sh, th, bl, cl</i> and <i>fl</i> |
| Sing a song |
| Read a sequence of conversations that make a story |
| Read about places in Jordan |
| Write sentences about actions using the correct punctuation |
| Complete emails |

a. Fair

b. Good

c. Excellent

Unit 9 Review

What did I learn in Units 5–8 and what can I now do?

| |
|---|
| Listen to descriptions of pictures |
| Listen to a conversation related to travel |
| Ask and answer about what people are doing |
| Talk about travel |
| Pronounce words with the sounds <i>gl, pl, sl, dr, tr, br, cr, tw, gr, fr</i> and <i>pr</i> |
| Read about sea animals |
| Read about visiting places |
| Write answers to questions describing actions in pictures |
| Write sentences about daily actions |

a. Fair

b. Good

c. Excellent

Assessment

Unit 13 Review

What did I learn in Units 10–12 and what can I now do?

| |
|---|
| Listen to a description of a street |
| Listen to conversations about museums |
| Speak about cities in Jordan |
| Describe people |
| Pronounce words with the sounds <i>sk, sm, sn, sp, st, sw, ll, nk</i> and <i>mb</i> |
| Read about planets |
| Read about Amman |
| Write sentences to describe the months |
| Write sentences about a museum |

- a. Fair
- b. Good
- c. Excellent

Unit 18 Review

What did I learn in Units 14–17 and what can I now do?

| |
|---|
| Listen to a conversation about the past |
| Listen to a conversation about journeys |
| Speak about what we did in the past |
| Talk about what Kareem and Samira did |
| Pronounce words with the sounds <i>ck, nn, gh, tt, kn, ph, wr, spr, sq</i> and <i>str</i> |
| Sing a song |
| Read about what people did in the past |
| Read about planting trees |
| Write sentences about what I did and didn't do in the past |
| Write questions asking about what people did in the past |

- a. Fair
- b. Good
- c. Excellent